

Transport Service Licence

Registration

Certificate of Loading

Road User Charges

Warrant of fitness

Certificate of fitness

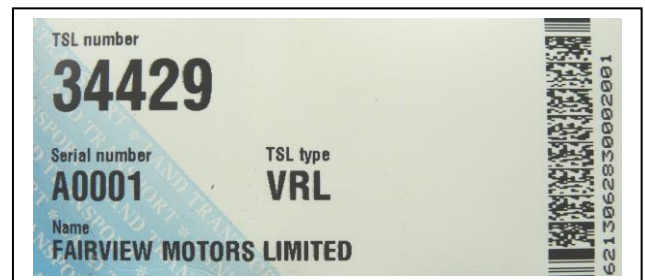
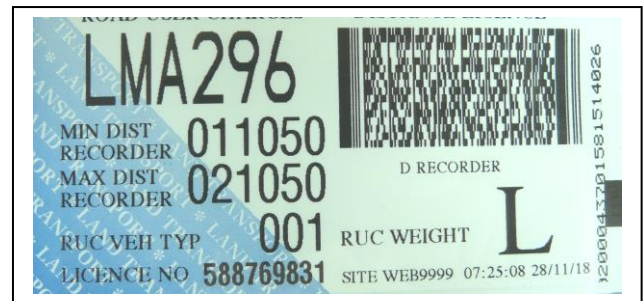

Manual transmission
Engine
Final drive
Axle shaft
Drive shaft
Clutch

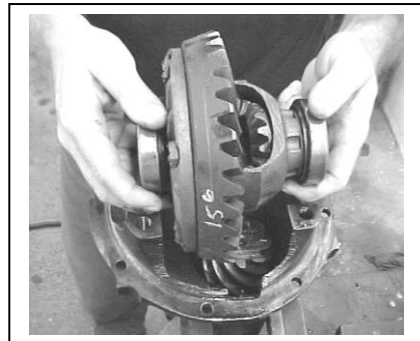
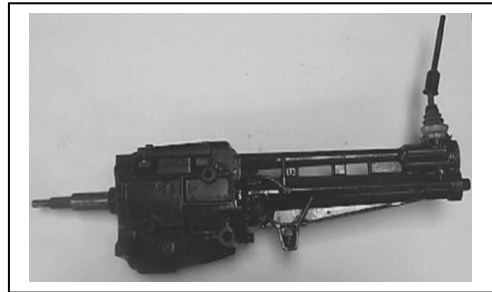
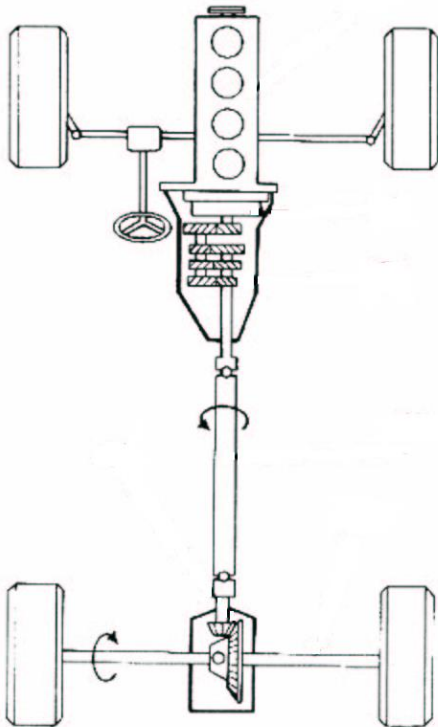

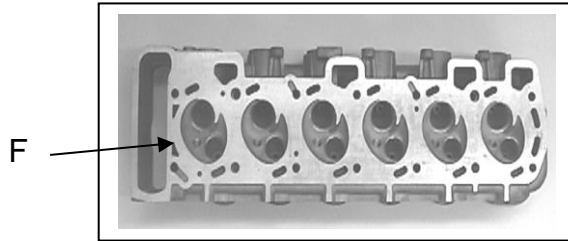
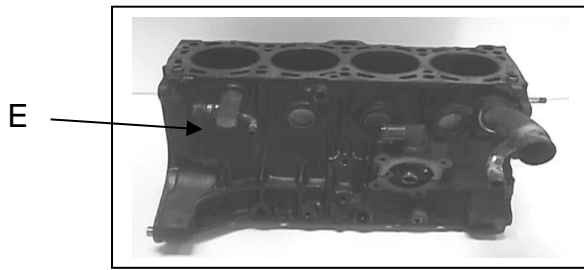

Cylinder block
Piston
Crankshaft
Exhaust manifold
Cylinder head
Cambelt

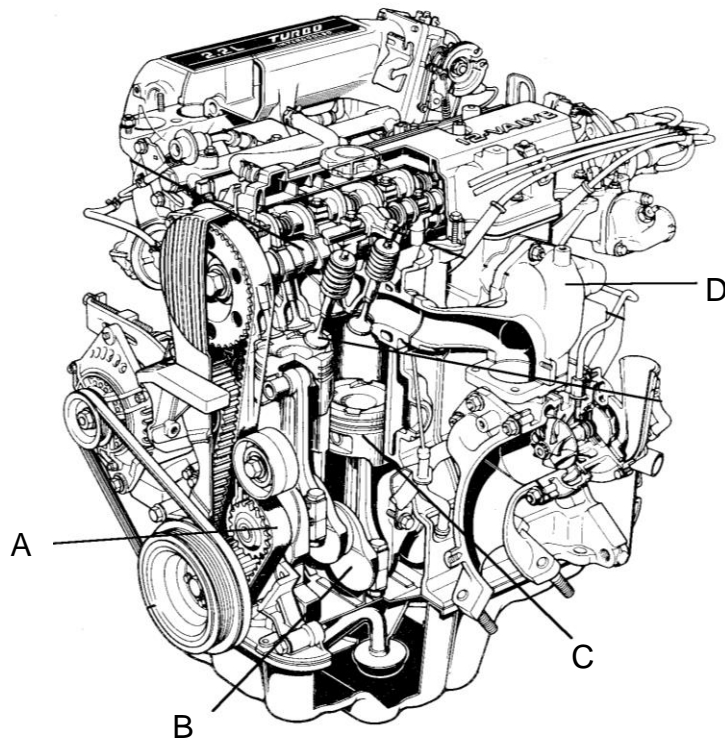

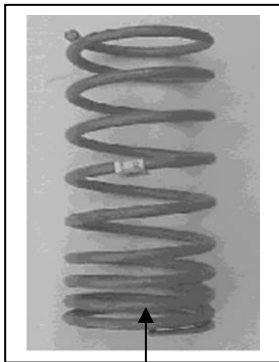
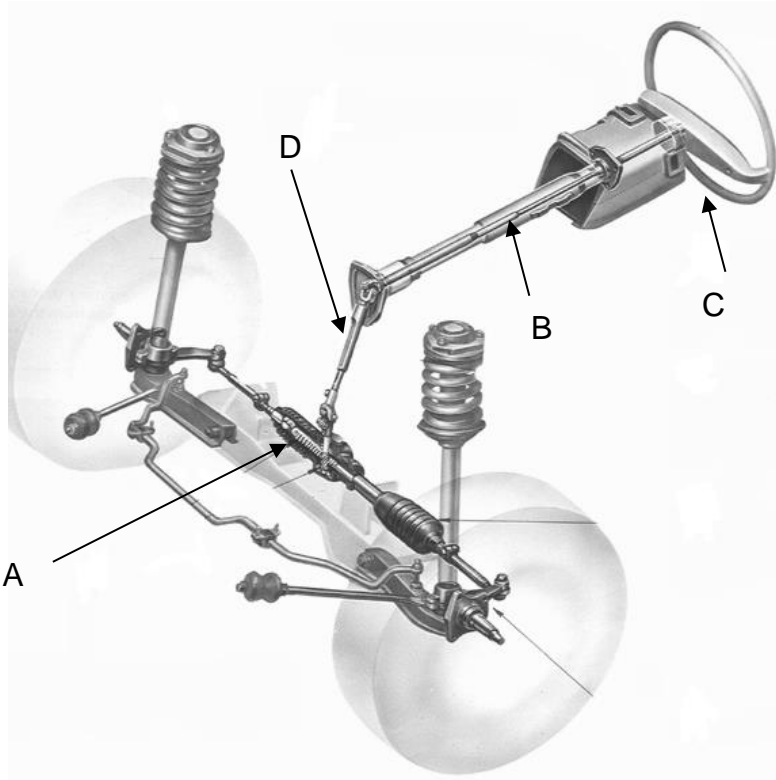

E

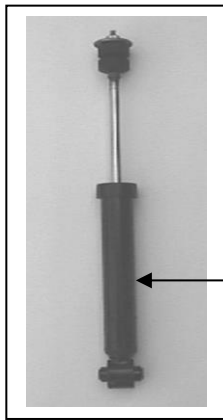

F

Steering column
Steering wheel
Shock absorber
Steering rack
Intermediate shaft
Coil spring

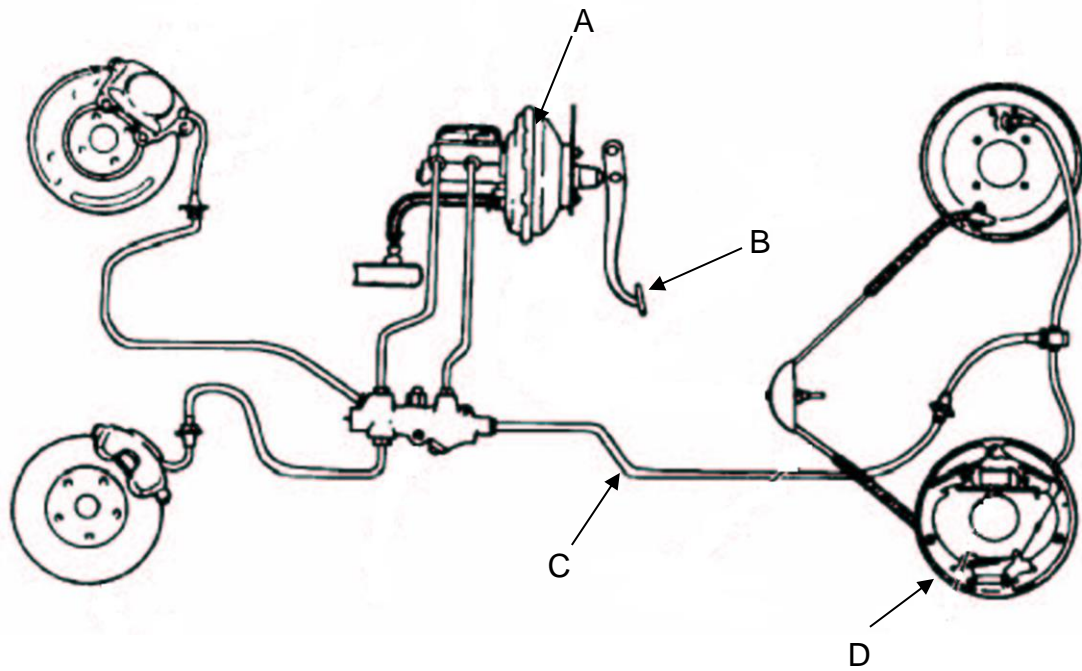

Front disc brake
Rear drum brake
Master cylinder
Brake pipe
Brake pedal
Brake booster

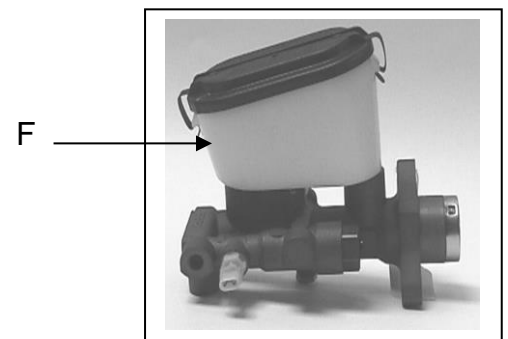
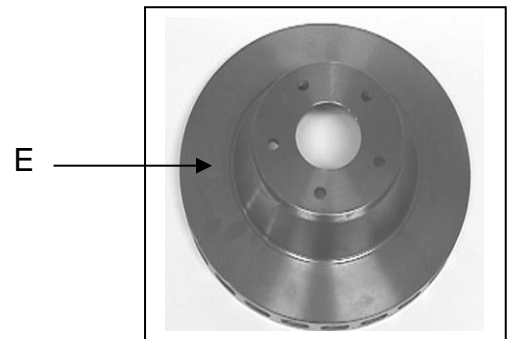



Side mirror
Bonnet
Grille
Front guard
Windscreen

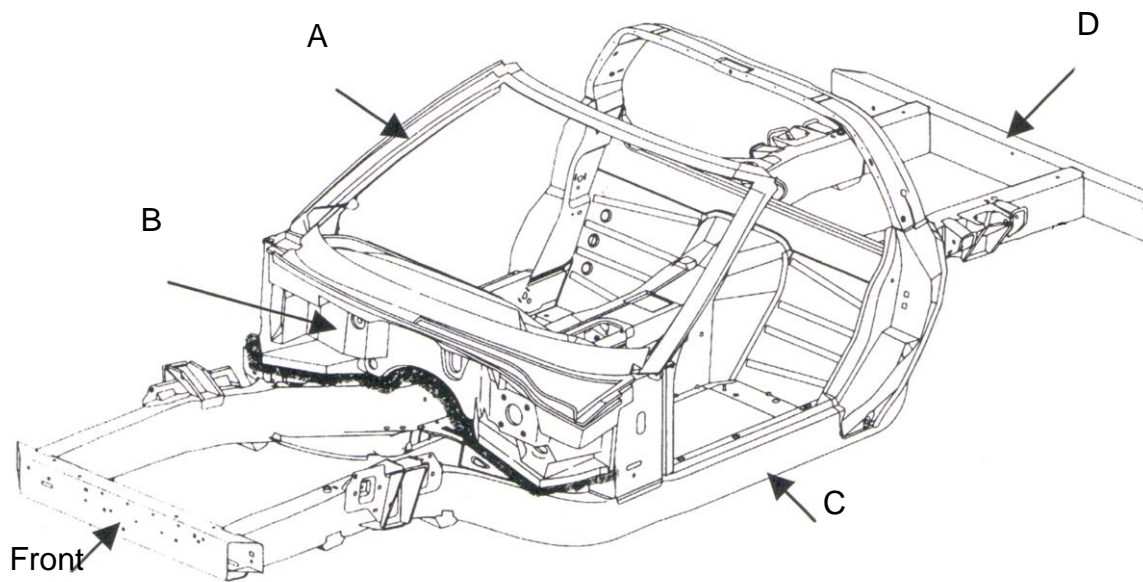

Firewall
Windscreen frame
Side chassis rail
Rear impact beam



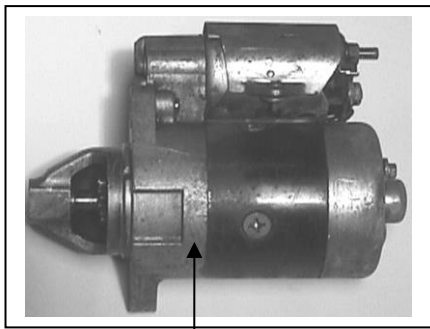
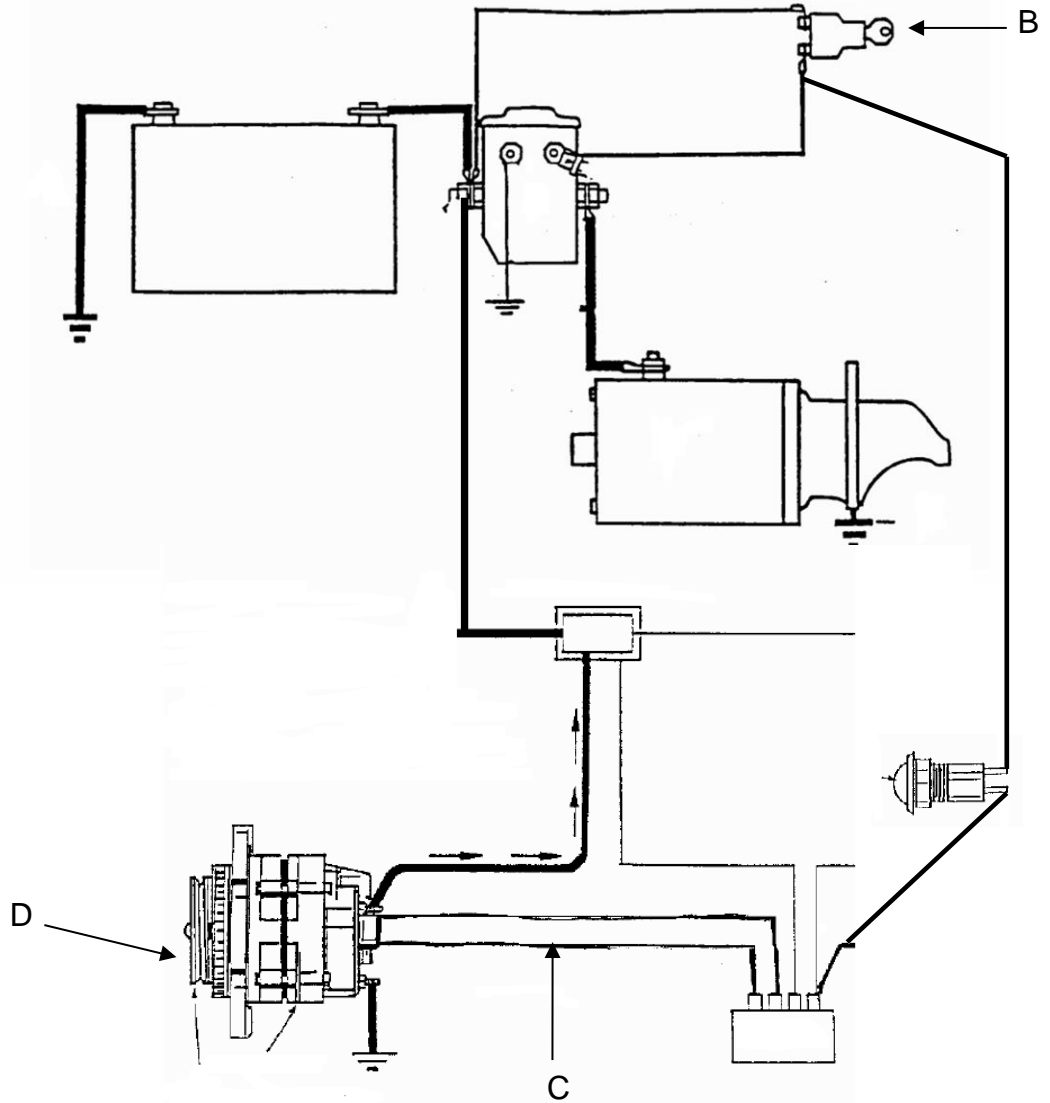

E

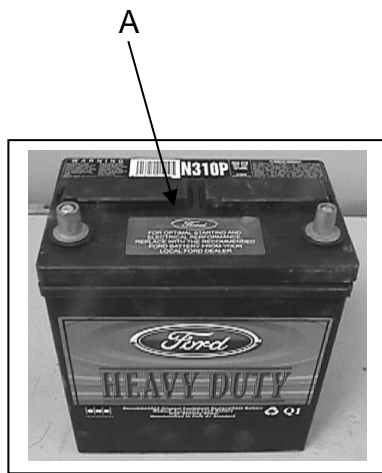

A

Wiring
Alternator
Starter motor
Battery
Ignition switch



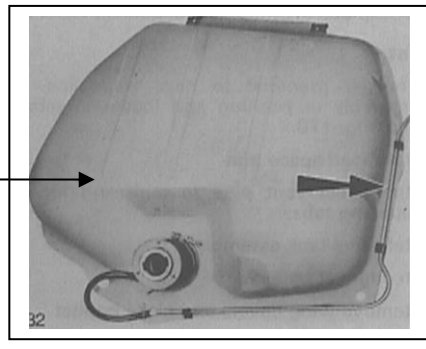
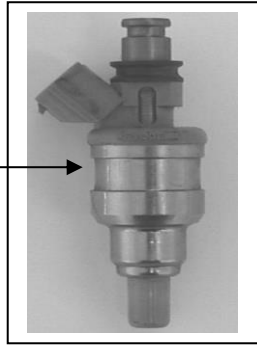
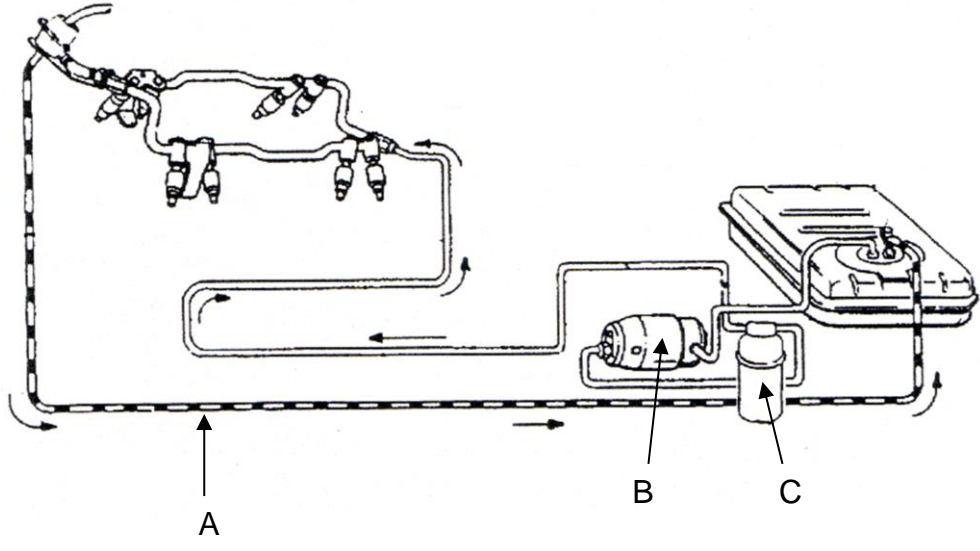

Fuel tank
Fuel line
Fuel Injector
Fuel pump
Fuel filter